

**Mesas Frias Gastronorm
Tables Froides Gastronorm
Gastronorm Refrigerated Counters
Gastronorm Kühltische
Tavoli refrigerati Gastronorm**

Modelos:

**MFP
MCP**



PLATON SERVICE

8 (800) 500-34-47

www.platonservice.com

Mayo 2003 May



Fagor Industrial

**RECAMBIOS
MESAS FRÍAS**
revisión 01-03-2003



MODELOS

MFP-135	MFP-180	MFP-225	MFP-270	MFP-102-R	MFP-147-R	MFP-192-R	MFP-237-R
---------	---------	---------	---------	-----------	-----------	-----------	-----------

Nº	CÓDIGO	DESCRIPCIÓN	GASTRO				GASTRO				
1	6021010007	COMPR.FR-8,5 - G R134A		1	1						
1	6021010015	COMPRESOR GP14 TG				1					
1	6021010004	COMPR.FR-7,5-G R134A	1								
2	6021050002	VENTILADOR 10W PATA PALA 220V	1	1	1	1					
3	6029020003	CONDENSADOR 9x3 FAGC0021				1					
3	6029020002	CONDENSADOR 9x2	1	1	1						
4	M129010004	BAT.MFP-270 8T4R330A4SC/TU(PIN				1					1
4	M129010002	BAT.MFP135 5T4R330A4SC/TUB(PIN	1	1	1		1	1	1		
5	6021050001	VENTIL.EVAPOR.5W ARO/TIRO FORZ	1	1	1	1	1	1	1	1	1
6	6003010035	REJILLA PROTECCION VENTILADOR	1	1	1	1	1	1	1	1	1
7	6021350015	TERMOSTATO TERM.REFRIG ID 961F	1	1	1	1	1	1	1	1	1
8	6021130001	INTERRUPTOR BIPOL.AMBAR.ON/OFF	1	1	1	1	1	1	1	1	1
9	6021130010	PILOTO RECTAN.AMBAR SEÑAL LUM.	1	1	1	1	1	1	1	1	1
10	M109050157	CHAPA PROT.MANDOS MESAS FRIAS	1	1	1	1					
11	6003010023	BANDEJA EVAPORACION AUTOMÁTICA	1	1	1	1					
13	6003010034	DESAGÜE SAN MIGUEL	1	1	1	1	1	1	1	1	1
14	6007050015	PATA REGUL. 50X95 BAJOS	4	4	4	4	4	4	4	4	4
15	M161250002	BASE PATAS MFP 600X100 PINTAD	1	1	1	1	1	1	1	1	1
16	V169090001	BISAGRA SISTEMA GIRO A IZDA	2	3	4	5	2	3	4	5	
17	6003010048	SOPORTE PUERTA REJILLA	2	2	2	2					
18	6003010032	ESCUADRA AMARRE REJILLA	1	1	1	1					
21	6003010181	REJ.RESP.GRUPO 387X280POLICARB	1	1	1	1					
23	M109050122	CREMALL.LAT.POST.MFP DCHA.	1	1	1	1	1	1	1	1	1
23	M109050104	CREMALL.LAT.POST.MFP IZDA.	1	1	1	1	1	1	1	1	1
24	M109050105	CREMALLERA CENTRAL MFP	1	2	3	4	1	2	3	4	
25	M109050153	CREMALLERA MFP-MSP 576X66 MM	4	6	8	10	4	6	8	10	
26	6033050011	GUIA BAJO GN 1/1 L=549 MM	8	12	16	20	8	12	16	20	
27	6045010006	BURLETE 400X605 MFP GASTRO	2	3	4	5	2	3	4	5	
29	M169010012	PUERTA MFP AP IZDA TIR.ABS	2	3	4	5	2	3	4	5	
32	V107020005	CAPILAR 1.25x2100				1					
32	M107020001	CAPILAR 1x3300	1	1	1						
33	M181010014	ENCIMERA MFP270				1					
33	M181010013	ENCIMERA MFP225			1						
33	M181010011	ENCIMERA MFP135	1								
33	M181010015	ENCIMERA MFP102					1				
33	M181010012	ENCIMERA MFP180		1							
33	M181010018	ENCIMERA MFP-237									1
33	M181010017	ENCIMERA MFP192								1	
33	M181010016	ENCIMERA MFP147						1			
35	M109250003	PROTECTOR ENCIMERA 135	1				1				
35	M109250004	PROTECTOR ENCIM. 180		1				1			
35	M109250034	PROTECT. ENCIM. 225			1	1			1	1	
35	M109250036	PROTECT. ENCIM. SUPLE. 270				1					1
36	6001050032	AGLOM.2690X670X13 ENC. MFP-270				1					1
36	6001050030	AGLOM.1340X670X13 ENC.MFP-135	1				1				
36	6001050020	AGLOM.2240X670X13 ENC. MFP-225			1					1	
36	6001050019	AGLOM.1790X670X13 ENC. MFP-180		1				1			
37	6013050007	PL.POLIEST.1310X566X30 TIPO IV		1		1		1			1
37	6013050005	PL.POLIEST.860X566X30 MM	1		2		1		2		
38	M109010334	REJILLA CUADRO ABS GRIS MSP	1	1	1	1					
38	M109010335	CUADRO DE MANDOS MSN-R R7					1	1	1	1	
40	M109010150	COST EXT LAD GRUP MFP-R					1	1	1	1	
40	M109010042	COST EXT LAD GRUP MFP	1	1	1	1					
41	6027010003	PARRILLA GN1/1 530x325	2	3	4	5	2	3	4	5	
46	6047010003	FILTRO DESHIDRAT.40GR 1/4X1/4	1	1	1	1					
48	6021350013	SONDA TERMOST.REF NTC 15KOhm	1	1	1	1	1	1	1	1	
50	6003010105	CUADRO ABS GRIS	1	1	1	1					
55	6037050002	SOPORTE COST.RODAP.MFP 230X600					1	1	1	1	
66	6003050001	GAVETA TIRO FORZADO GASTRO	1	1	1	1	1	1	1	1	
67	6021010045	RELE ARRANQUE COMPRESOR FR-7,5-G 6001	1								
67	6021010017	RELE COMPRESOR GP-14TG RF 5127				1					
67	6021010025	RELE ARRANQUE COMPRESOR FR-8,5G		1	1						
68	6021010041	CONDENS.ARRANQ GL-TG 47 microF				1					
68	6021010037	CONDENSADOR ARRANQUE FR 17U5015 80microF	1	1	1						

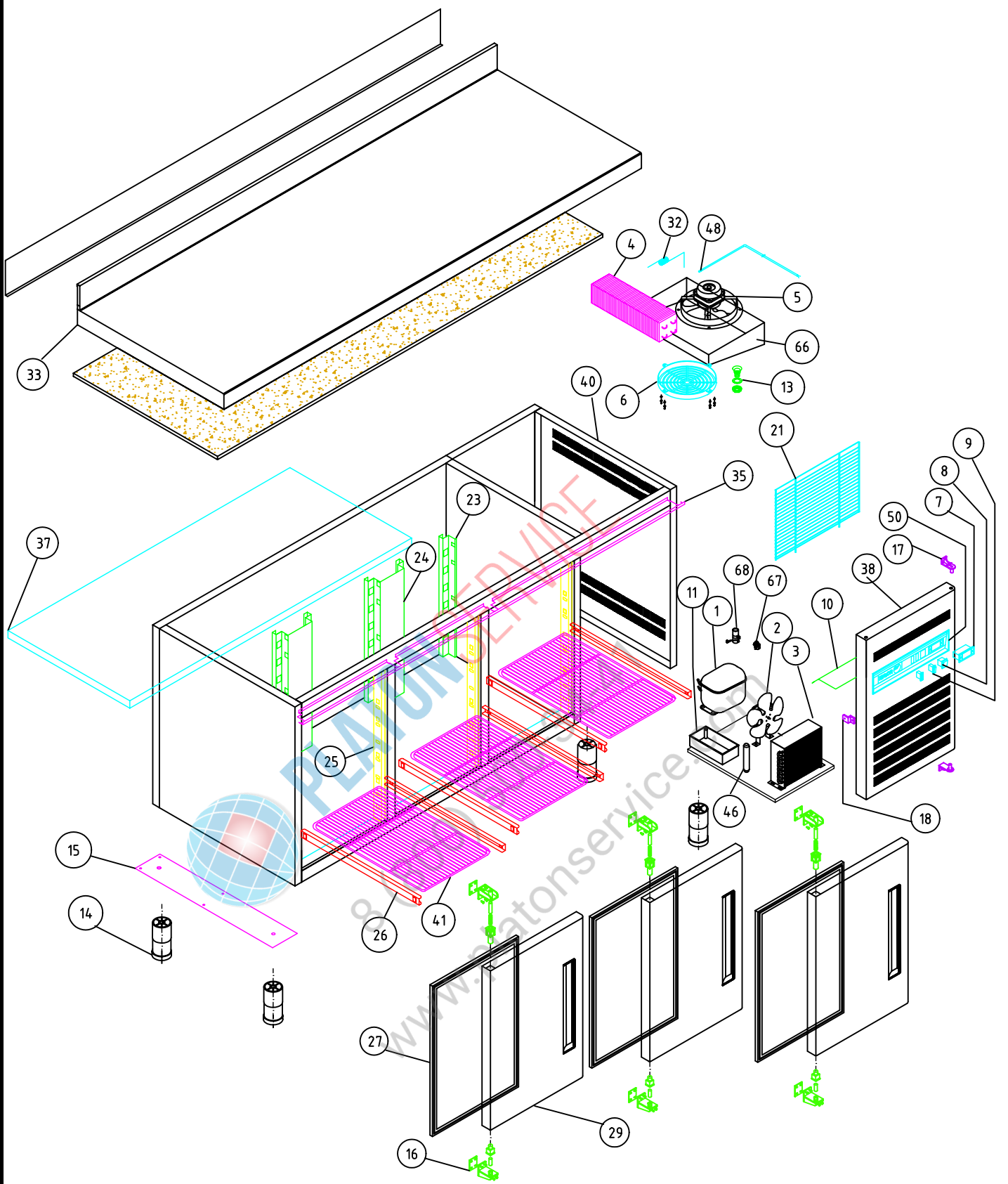

M1 MESAS FRÍAS				COD. PIEZA:					
COTAS SIN TOLERANCIA DIN 7168-f				Material: MATERIAL ESPESOR					
				Acabado: ACABADO					
ANGULAR	GRADO TOLERANCIA	FINO	MEDIO	GRUESO					
	HASTA 10 mm		±1°	±1° 30'					
	MÁS DE 10 A 50 mm		±30'	±50'					
	MÁS DE 50 A 120 mm		±20'	±25'					
	MÁS DE 120 A 400 mm		±10'	±15'					
	MÁS DE 400 mm		±5'	±10'					
LINEAL	GRADO TOLERANCIA	FINO	MEDIO	GRUESO					
	HASTA 3 mm		±0,05	±0,10	±0,15				
	MÁS DE 3 A 6 mm		±0,05	±0,10	±0,20				
	MÁS DE 6 A 30 mm		±0,10	±0,20	±0,50				
	MÁS DE 30 A 120 mm		±0,15	±0,30	±0,80				
	MÁS DE 120 A 400 mm		±0,20	±0,50	±1,20				
	MÁS DE 400 A 1000 mm		±0,30	±0,80	±2,00				
	MÁS DE 1000 A 2000 mm		±0,50	±1,20	±3,00				
Material: MATERIAL ESPESOR		Acabado: ACABADO		SUSTITUYE A:		SUSTITUIDO POR:			
COMÚN A	MODELO	Ud.	MODELO	Ud.	MODELO	Ud.	MODELO		
	MFP-180	1							
A4	Nombre	Fecha		FAGOR FAGOFRI s.a. 					
Dibujado	MJGG	3-3-03							
Modificado									
Escala	1:22			RECAMBIOS MFP					
							Código máquina: CODIGO		

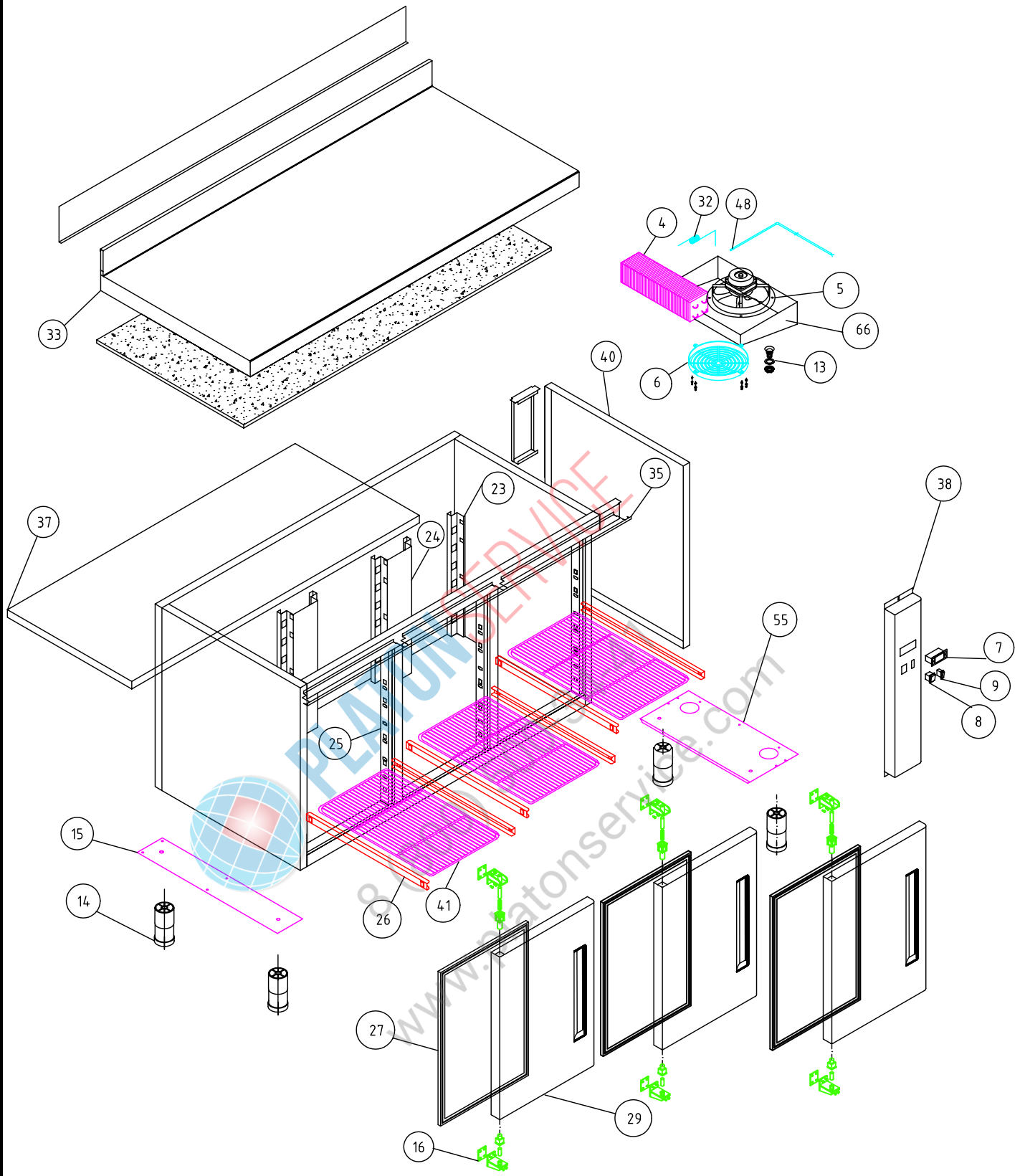

M1 MESAS FRÍAS				COD. PIEZA: X																																																																											
COTAS SIN TOLERANCIA DIN 7168-f				Material: MATERIAL ESPESOR																																																																											
<table border="1"> <thead> <tr> <th>GRADO TOLERANCIA</th> <th>FINO</th> <th>MEDIO</th> <th>GRUESO</th> </tr> </thead> <tbody> <tr> <td>HASTA 10 mm</td> <td>±1°</td> <td></td> <td>±1° 30'</td> </tr> <tr> <td>MAS DE 10 A 50 mm</td> <td>±30'</td> <td></td> <td>±50'</td> </tr> <tr> <td>MAS DE 50 A 120 mm</td> <td>±20'</td> <td></td> <td>±25'</td> </tr> <tr> <td>MAS DE 120 A 400 mm</td> <td>±10'</td> <td></td> <td>±15'</td> </tr> <tr> <td>MAS DE 400 mm</td> <td>±5'</td> <td></td> <td>±10'</td> </tr> </tbody> </table>				GRADO TOLERANCIA	FINO	MEDIO	GRUESO	HASTA 10 mm	±1°		±1° 30'	MAS DE 10 A 50 mm	±30'		±50'	MAS DE 50 A 120 mm	±20'		±25'	MAS DE 120 A 400 mm	±10'		±15'	MAS DE 400 mm	±5'		±10'	Acabado: ACABADO																																																			
GRADO TOLERANCIA	FINO	MEDIO	GRUESO																																																																												
HASTA 10 mm	±1°		±1° 30'																																																																												
MAS DE 10 A 50 mm	±30'		±50'																																																																												
MAS DE 50 A 120 mm	±20'		±25'																																																																												
MAS DE 120 A 400 mm	±10'		±15'																																																																												
MAS DE 400 mm	±5'		±10'																																																																												
<table border="1"> <thead> <tr> <th>ANGULAR</th> <th>FINO</th> <th>MEDIO</th> <th>GRUESO</th> </tr> </thead> <tbody> <tr> <td>HASTA 3 mm</td> <td>±0,05</td> <td>±0,10</td> <td>±0,15</td> </tr> <tr> <td>MAS DE 3 A 6 mm</td> <td>±0,05</td> <td>±0,10</td> <td>±0,20</td> </tr> <tr> <td>MAS DE 6 A 30 mm</td> <td>±0,10</td> <td>±0,20</td> <td>±0,50</td> </tr> <tr> <td>MAS DE 30 A 120 mm</td> <td>±0,15</td> <td>±0,30</td> <td>±0,80</td> </tr> <tr> <td>MAS DE 120 A 400 mm</td> <td>±0,20</td> <td>±0,50</td> <td>±1,20</td> </tr> <tr> <td>MAS DE 400 A 1000 mm</td> <td>±0,30</td> <td>±0,80</td> <td>±2,00</td> </tr> <tr> <td>MAS DE 1000 A 2000 mm</td> <td>±0,50</td> <td>±1,20</td> <td>±3,00</td> </tr> </tbody> </table>				ANGULAR	FINO	MEDIO	GRUESO	HASTA 3 mm	±0,05	±0,10	±0,15	MAS DE 3 A 6 mm	±0,05	±0,10	±0,20	MAS DE 6 A 30 mm	±0,10	±0,20	±0,50	MAS DE 30 A 120 mm	±0,15	±0,30	±0,80	MAS DE 120 A 400 mm	±0,20	±0,50	±1,20	MAS DE 400 A 1000 mm	±0,30	±0,80	±2,00	MAS DE 1000 A 2000 mm	±0,50	±1,20	±3,00	<table border="1"> <thead> <tr> <th>COMUN A</th> <th>MODELO</th> <th>Ud.</th> <th>MODELO</th> <th>Ud.</th> <th>MODELO</th> <th>Ud.</th> <th>MODELO</th> <th>Ud.</th> <th>MODELO</th> </tr> </thead> <tbody> <tr> <td></td> <td>MFP-147-R</td> <td>1</td> <td></td> <td></td> <td></td> <td></td> <td></td> <td></td> <td></td> </tr> <tr> <td></td> <td></td> <td></td> <td></td> <td></td> <td></td> <td></td> <td></td> <td></td> <td></td> </tr> <tr> <td></td> <td></td> <td></td> <td></td> <td></td> <td></td> <td></td> <td></td> <td></td> <td></td> </tr> </tbody> </table>				COMUN A	MODELO	Ud.	MODELO	Ud.	MODELO	Ud.	MODELO	Ud.	MODELO		MFP-147-R	1																											
ANGULAR	FINO	MEDIO	GRUESO																																																																												
HASTA 3 mm	±0,05	±0,10	±0,15																																																																												
MAS DE 3 A 6 mm	±0,05	±0,10	±0,20																																																																												
MAS DE 6 A 30 mm	±0,10	±0,20	±0,50																																																																												
MAS DE 30 A 120 mm	±0,15	±0,30	±0,80																																																																												
MAS DE 120 A 400 mm	±0,20	±0,50	±1,20																																																																												
MAS DE 400 A 1000 mm	±0,30	±0,80	±2,00																																																																												
MAS DE 1000 A 2000 mm	±0,50	±1,20	±3,00																																																																												
COMUN A	MODELO	Ud.	MODELO	Ud.	MODELO	Ud.	MODELO	Ud.	MODELO																																																																						
	MFP-147-R	1																																																																													
<table border="1"> <thead> <tr> <th>LINEAL</th> <th>FINO</th> <th>MEDIO</th> <th>GRUESO</th> </tr> </thead> <tbody> <tr> <td>HASTA 3 mm</td> <td>±0,05</td> <td>±0,10</td> <td>±0,15</td> </tr> <tr> <td>MAS DE 3 A 6 mm</td> <td>±0,05</td> <td>±0,10</td> <td>±0,20</td> </tr> <tr> <td>MAS DE 6 A 30 mm</td> <td>±0,10</td> <td>±0,20</td> <td>±0,50</td> </tr> <tr> <td>MAS DE 30 A 120 mm</td> <td>±0,15</td> <td>±0,30</td> <td>±0,80</td> </tr> <tr> <td>MAS DE 120 A 400 mm</td> <td>±0,20</td> <td>±0,50</td> <td>±1,20</td> </tr> <tr> <td>MAS DE 400 A 1000 mm</td> <td>±0,30</td> <td>±0,80</td> <td>±2,00</td> </tr> <tr> <td>MAS DE 1000 A 2000 mm</td> <td>±0,50</td> <td>±1,20</td> <td>±3,00</td> </tr> </tbody> </table>				LINEAL	FINO	MEDIO	GRUESO	HASTA 3 mm	±0,05	±0,10	±0,15	MAS DE 3 A 6 mm	±0,05	±0,10	±0,20	MAS DE 6 A 30 mm	±0,10	±0,20	±0,50	MAS DE 30 A 120 mm	±0,15	±0,30	±0,80	MAS DE 120 A 400 mm	±0,20	±0,50	±1,20	MAS DE 400 A 1000 mm	±0,30	±0,80	±2,00	MAS DE 1000 A 2000 mm	±0,50	±1,20	±3,00	A4		Nombre		Fecha																																							
LINEAL	FINO	MEDIO	GRUESO																																																																												
HASTA 3 mm	±0,05	±0,10	±0,15																																																																												
MAS DE 3 A 6 mm	±0,05	±0,10	±0,20																																																																												
MAS DE 6 A 30 mm	±0,10	±0,20	±0,50																																																																												
MAS DE 30 A 120 mm	±0,15	±0,30	±0,80																																																																												
MAS DE 120 A 400 mm	±0,20	±0,50	±1,20																																																																												
MAS DE 400 A 1000 mm	±0,30	±0,80	±2,00																																																																												
MAS DE 1000 A 2000 mm	±0,50	±1,20	±3,00																																																																												
Dibujado		MJGG		11-4-03		 Fagofri, s.a.																																																																									
Modificado																																																																															
Escala		1:22		RECAMBIOS MFP-REMOTA																																																																											
						Código máquina:																																																																									
						CODIGO																																																																									

**RECAMBIOS
MESAS FRÍAS**

revisión 01-03-2003



MODELOS

MFP-135-F	MFP-180-F	MFP-225-F	MFP-270-F
-----------	-----------	-----------	-----------

Nº	CÓDIGO	DESCRIPCIÓN	GASTRO			
			MFP-135-F	MFP-180-F	MFP-225-F	MFP-270-F
1	6021010007	COMPR.FR-8,5 - G R134A		1	1	
1	6021010015	COMPRESOR GP14 TG				1
1	6021010004	COMPR.FR-7,5-G R134A	1			
2	6021050002	VENTILADOR 10W PATA PALA 220V	1	1	1	1
3	6029020003	CONDENSADOR 9x3 FAGC0021				1
3	6029020002	CONDENSADOR 9x2	1	1	1	
4	M129010004	BAT.MFP-270 8T4R330A4SC/TU(PIN				1
4	M129010002	BAT.MFP135 5T4R330A4SC/TUB(PIN	1	1	1	
5	6021050001	VENTIL.EVAPOR.5W ARO/TIRO FORZ	1	1	1	1
6	6003010035	REJILLA PROTECCION VENTILADOR	1	1	1	1
7	6021350015	TERMOSTATO TERM.REFRIG ID 961F	1	1	1	1
8	6021130001	INTERRUPTOR BIPOL.AMB.ON/OFF	1	1	1	1
9	6021130010	PILOTO RECTAN.AMBAR SEÑAL LUM.	1	1	1	1
10	M109050157	CHAPA PROT.MANDOS MESAS FRÍAS	1	1	1	1
11	6003010023	BANDEJA EVAPORACION AUTOMÁTICA	1	1	1	1
13	6003010034	DESAGÜE SAN MIGUEL	1	1	1	1
14	6007050015	PATA REGUL. 50X95 BAJOS	4	4	4	4
15	M161250002	BASE PATAS MFP 600X100 PINTAD	1	1	1	1
16	V169090001	BISAGRA SISTEMA GIRO A IZDA	2	3	4	5
17	6003010048	SOPORTE PUERTA REJILLA	2	2	2	2
18	6003010032	ESCUADRA AMARRE REJILLA	1	1	1	1
21	6003010181	REJ.RESP.GRUPO 387X280POLICARB	1	1	1	1
23	M109050122	CREMALL.LAT.POST.MFP DCHA.	1	1	1	1
23	M109050104	CREMALL.LAT.POST.MFP IZDA.	1	1	1	1
24	M109050105	CREMALLERA CENTRAL MFP	1	2	3	4
25	M109050153	CREMALLERA MFP-MSP 576X66 MM	4	6	8	10
26	6033050011	GUIA BAJO GN 1/1 L=549 MM	8	12	16	20
27	6045010006	BURLETE 400X605 MFP GASTRO	2	3	4	5
29	M169010012	PUERTA MFP R-7 AP IZDA	2	3	4	5
32	V107020005	CAPILAR 1.25x2100				1
32	M107020001	CAPILAR 1x3300	1	1	1	
33	M181010047	ENCIMERA CON FREGADERO MFP-135	1			
33	M181010048	ENCIMERA CON FREGADERO MFP-180		1		
33	M181010049	ENCIMERA CON FREGADERO MFP-225			1	
33	M181010050	ENCIMERA CON FREGADERO MFP-270				1
35	M109250003	PROTECTOR ENCIMERA 135	1			
35	M109250004	PROTECTOR ENCIM. 180		1		
35	M109250034	PROTECT. ENCIM. 225			1	1
35	M109250036	PROTECT. ENCIM. SUPLE. 270				1
36	6001050032	AGLOM.2690X670X13 ENC. MFP-270				1
36	6001050030	AGLOM.1340X670X13 ENC.MFP-135	1			
36	6001050020	AGLOM.2240X670X13 ENC. MFP-225			1	
36	6001050019	AGLOM.1790X670X13 ENC. MFP-180		1		
37	6013050007	PL.POLIEST.1310X566X30 TIPO IV		1		1
37	6013050005	PL.POLIEST.860X566X30 MM	1		2	
38	M109010334	REJILLA CUADRO ABS GRIS MSP	1	1	1	1
40	M109010042	COST EXT LAD GRUP MFP	1	1	1	1
41	6027010003	PARRILLA GN1/1 530x325	2	3	4	5
46	6047010003	FILTRO DESHIDRAT.40GR 1/4X1/4	1	1	1	1
48	6021350013	SONDA TERMOST.REF NTC 15KOhm	1	1	1	1
50	6003010105	CUADRO ABS GRIS	1	1	1	1
55	6037050002	SOPORTE COST.RODAP.MFP 230X600	1	1	1	1
66	6003050001	GAVETA TIRO FORZADO GASTRO	1	1	1	1
67	6021010045	RELE ARRANQUE COMPRESOR FR-7,5-G 6001	1			
67	6021010017	RELE COMPRESOR GP-14TG RF 5127				1
67	6021010025	RELE ARRANQUE COMPRESOR FR-8,5G		1	1	
68	6021010041	CONDENS.ARRANQ GL-TG 47 microF				1
68	6021010037	CONDENSADOR ARRANQUE FR 17U5015 80microF	1	1	1	

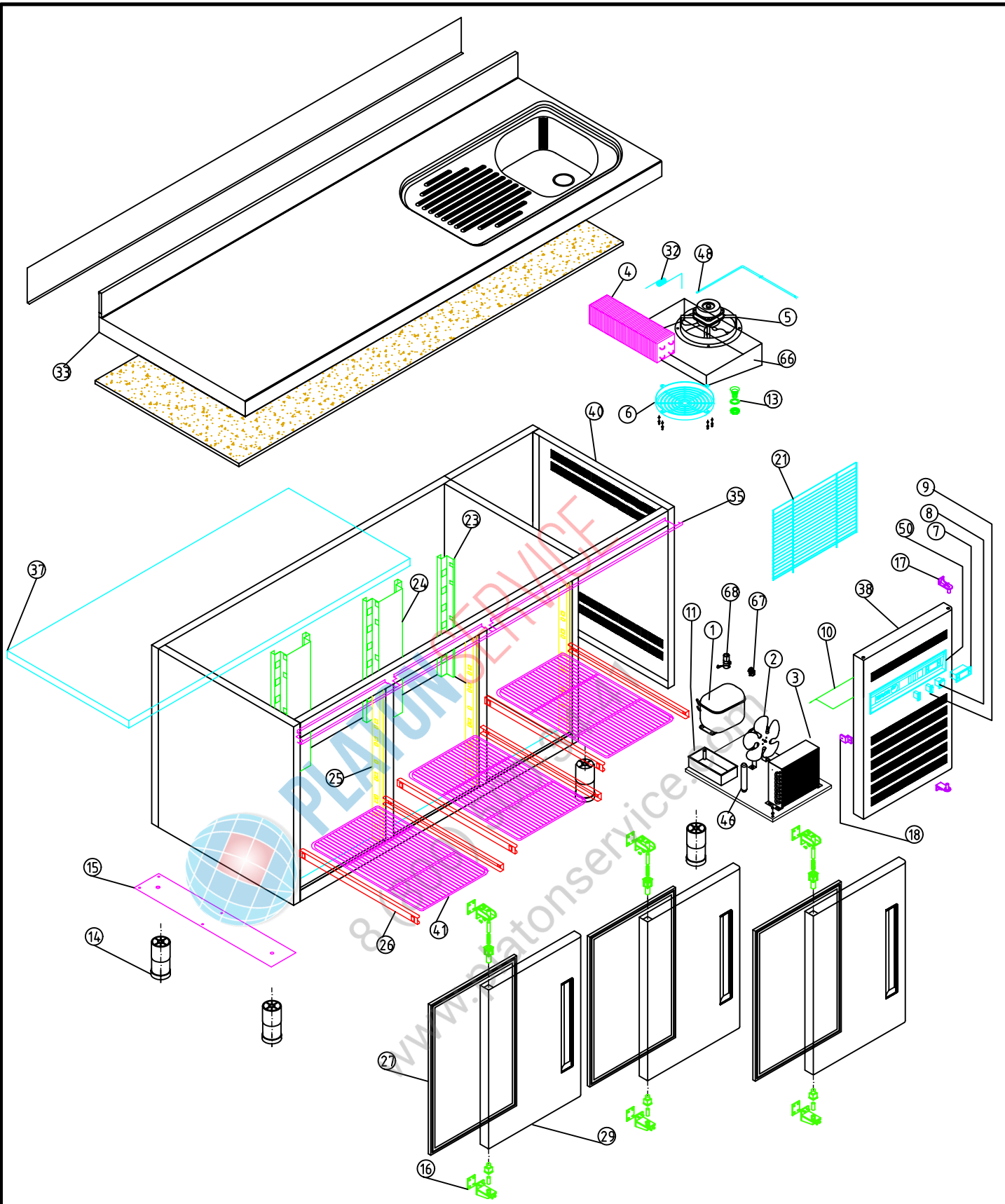

M1 MESAS FRÍAS				COD. PIEZA:				
COTAS SIN TOLERANCIA DIN 7168-f				Material: MATERIAL ESPESOR				
				Acabado: ACABADO				
ANGULAR	GRADO TOLERANCIA	FINO	MEDIO	GRUESO	SUSTITUYE A:		SUSTITUIDO POR:	
	HASTA 10 mm	±1°		±1° 30'	MODELO	Ud.	MODELO	Ud.
	MÁS DE 10 A 50 mm	±30'		±50'	MFP-180-F	1		
	MÁS DE 50 A 120 mm	±20'		±25'				
MÁS DE 120 A 400 mm	±10'		±15'					
MÁS DE 400 mm	±5'		±10'					
LINEAL	GRADO TOLERANCIA	FINO	MEDIO	GRUESO	Nombre		Fecha	
	HASTA 3 mm	±0,05	±0,10	±0,15	A4		3-3-03	
	MÁS DE 3 A 6 mm	±0,05	±0,10	±0,20	Dibujado	MJGG		
	MÁS DE 6 A 30 mm	±0,10	±0,20	±0,50	Modificado			
	MÁS DE 30 A 120 mm	±0,15	±0,30	±0,80	Escala			
	MÁS DE 120 A 400 mm	±0,20	±0,50	±1,20	1:22			
	MÁS DE 400 A 1000 mm	±0,30	±0,80	±2,00	RECAMBIOS MFP-FREGADERO			
	MÁS DE 1000 A 2000 mm	±0,50	±1,20	±3,00				
				FAGOR				
				FAGOFRI s.a.				
								
				Código máquina:				
				CODIGO				

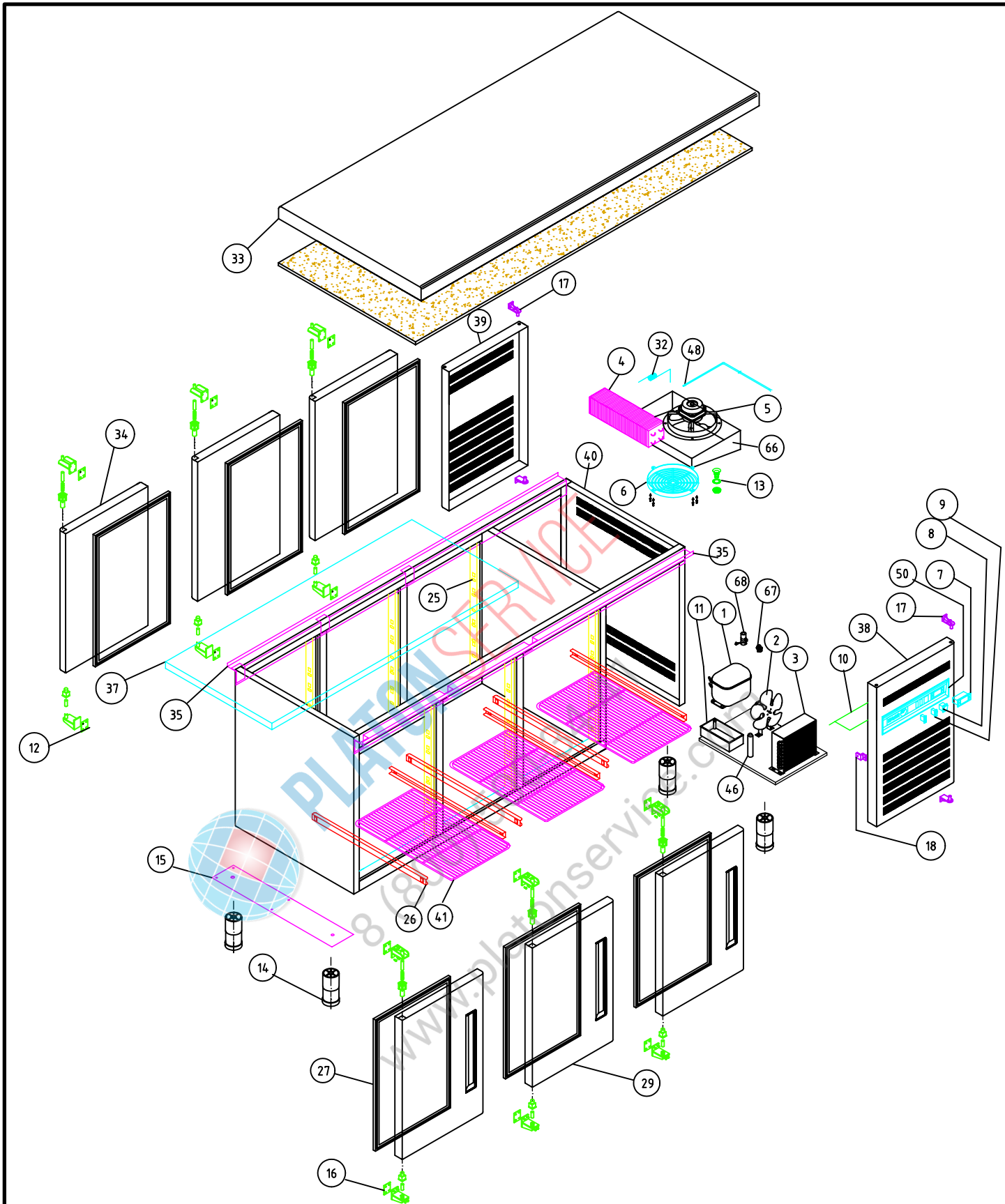

M1 MESAS FRÍAS GARTRONORM				COD. PIEZA: X				
COTAS SIN TOLERANCIA DIN 7168-f				Material: MATERIAL ESPESOR				
				Acabado: ACABADO				
ANGULAR	GRADO TOLERANCIA	FINO	MEDIO	GRUESO	SUSTITUYE A:			
	HASTA 10 mm	±1°		±1° 30'	SUSTITUIDO POR:			
	MAS DE 10 A 50 mm	±30'		±50'	MODELO	Ud.	MODELO	Ud.
	MAS DE 50 A 120 mm	±20'		±25'	MCP-180-GN	1		
MAS DE 120 A 400 mm	±10'		±15'					
MAS DE 400 mm	±5'		±10'					
LINEAL	GRADO TOLERANCIA	FINO	MEDIO	GRUESO	Nombre			FAGOR FAGOFRI s.a.
	HASTA 3 mm	±0,05	±0,10	±0,15	Fecha			
	MAS DE 3 A 6 mm	±0,05	±0,10	±0,20	.6-3-03			
	MAS DE 6 A 30 mm	±0,10	±0,20	±0,50	Dibujado MJGG			
	MAS DE 30 A 120 mm	±0,15	±0,30	±0,80	Modificado			
	MAS DE 120 A 400 mm	±0,20	±0,50	±1,20	Escala			
	MAS DE 400 A 1000 mm	±0,30	±0,80	±2,00	1:25			
MAS DE 1000 A 2000 mm	±0,50	±1,20	±3,00	RECAMBIOS MCP-180-GN				Código máquina: CODIGO

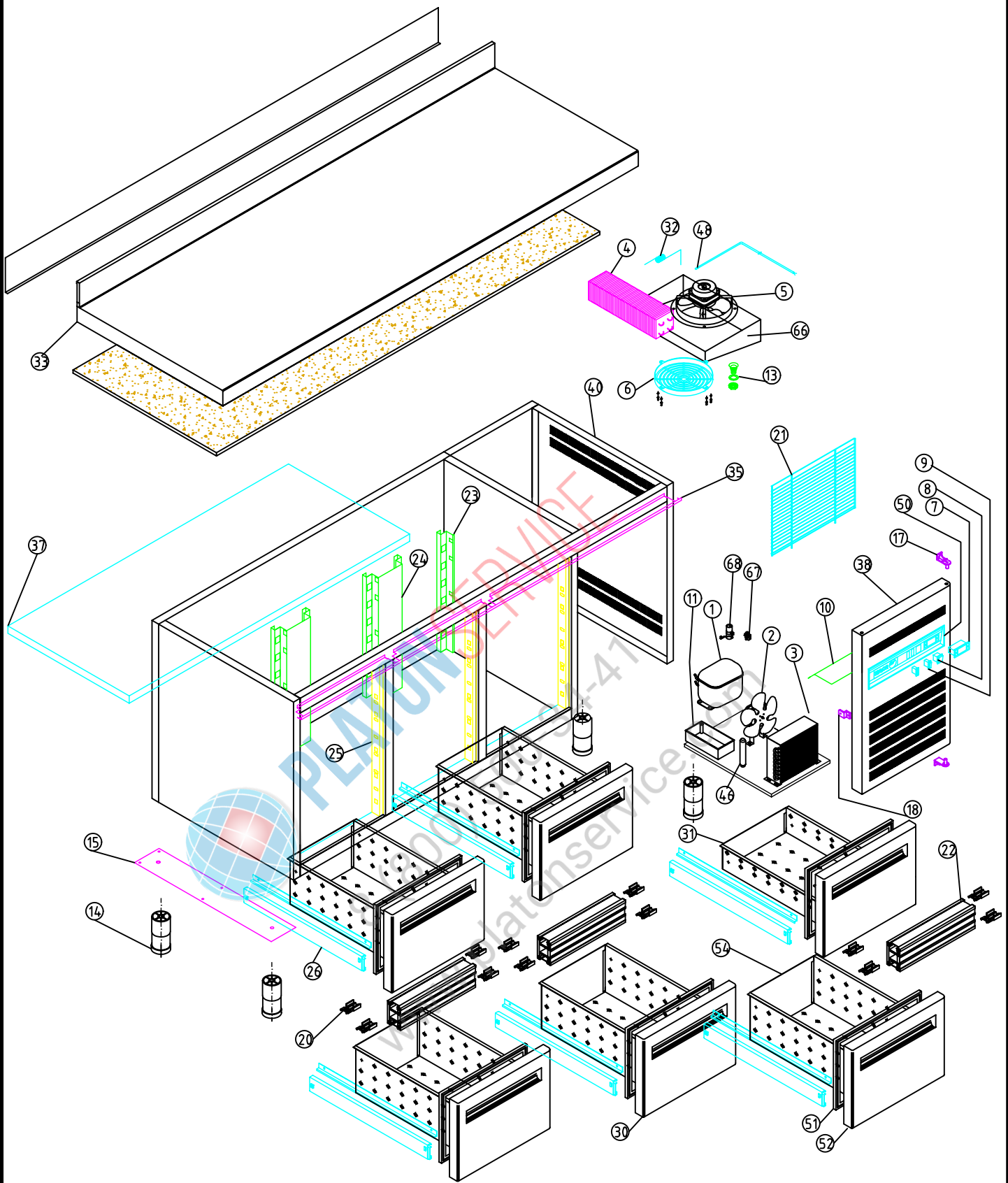

M1 MESAS FRÍAS				COD. PIEZA:																											
COTAS SIN TOLERANCIA DIN 7168-f				Material:																											
<table border="1"> <thead> <tr> <th>GRADO TOLERANCIA</th> <th>FINO</th> <th>MEDIO</th> <th>GRUESO</th> </tr> </thead> <tbody> <tr> <td>HASTA 10 mm</td> <td>±1°</td> <td></td> <td>±1° 30'</td> </tr> <tr> <td>MAS DE 10 A 50 mm</td> <td>±30'</td> <td></td> <td>±50'</td> </tr> <tr> <td>MAS DE 50 A 120 mm</td> <td>±20'</td> <td></td> <td>±25'</td> </tr> <tr> <td>MAS DE 120 A 400 mm</td> <td>±10'</td> <td></td> <td>±15'</td> </tr> <tr> <td>MAS DE 400 mm</td> <td>±5'</td> <td></td> <td>±10'</td> </tr> </tbody> </table>				GRADO TOLERANCIA	FINO	MEDIO	GRUESO	HASTA 10 mm	±1°		±1° 30'	MAS DE 10 A 50 mm	±30'		±50'	MAS DE 50 A 120 mm	±20'		±25'	MAS DE 120 A 400 mm	±10'		±15'	MAS DE 400 mm	±5'		±10'	Acabado:			
GRADO TOLERANCIA	FINO	MEDIO	GRUESO																												
HASTA 10 mm	±1°		±1° 30'																												
MAS DE 10 A 50 mm	±30'		±50'																												
MAS DE 50 A 120 mm	±20'		±25'																												
MAS DE 120 A 400 mm	±10'		±15'																												
MAS DE 400 mm	±5'		±10'																												
ANGULAR	COMUN A		MODELO	Ud.	MODELO	Ud.	MODELO	Ud.	MODELO	Ud.																					
			MFP-180-6C	1																											
LINEAL	A4		Nombre	Fecha		FAGOR FAGOFRI s.a.		Código máquina:																							
	Dibujado		MJGG	3-3-03																											
	Modificado																														
	Escala		1:22		RECAMBIOS MFP- CAJONES																										